



**DTR Medical**<sup>®</sup>

AN  
INNOVIA  
MEDICAL  
COMPANY

# Sterile Single-use Skin Deep Precision



## About Innovia Medical

Innovia Medical is a family of specialty surgical companies that are passionately committed to partnering with medical professionals to help elevate the delivery of patient care and improve clinical outcomes.

### **ELEVATING CARE. IMPROVING OUTCOMES.**

Innovia Medical companies develop and manufacture a portfolio of product solutions designed with both the medical professional and their patients in mind, to deliver care that:

- Saves time for both the medical professional and patient
- Delivers a consistent and predictable care experience
- Improves patient confidence with reduced recovery times and less discomfort

Innovia Medical does this through a commitment to innovation leadership, unsurpassed product quality and a dedication to provide responsive, personalized customer service.

### **INNOVATION LEADERSHIP.**

Innovation leadership is fueled through our dedication to collaboration with medical professionals. We regularly seek feedback and input from physicians, nurses, and other medical professionals through product research, testing and development.

This allows us to truly understand the solutions medical professionals need, and guides our innovative culture focused on inventing new, industry-leading solutions and reinventing current solutions that make ordinary products extraordinary, across the specialty surgery spectrum.

### **UNSURPASSED PRODUCT QUALITY.**

Our products deliver proven solutions and dependability which is the result of rigorous quality control and a relentless commitment to ongoing manufacturing improvements. We use only the highest quality materials and subject all products to rigorous inspection protocols. This is why we're proud to have so many customers who have continued to rely on our solutions for more than forty years.

### **RESPONSIVE, PERSONALIZED CUSTOMER SERVICE.**

From our sales representatives to our customer service team, every associate at Innovia Medical strives to deliver an unrivaled customer experience. This begins by ensuring that each customer receives the product that is right for their specific needs. We provide assistance through technical support and live customer service representatives with extensive product knowledge, available throughout the day. We deliver quick and thorough responses, every time—from order and shipping confirmations to delivery date communications and more ensuring continuous satisfaction.

We know you're committed to providing the best patient care experience possible and that's why we commit to being your trusted partner helping you every step of the way. At Innovia Medical, we are not just products, we are part of the patient care solution.

**Learn more at [www.innoviamedical.com](http://www.innoviamedical.com)**

## Contents

<b>Forceps</b> <i>Including Birks Tying, Fine Suture, Gillies, Epilation, Adson, Mosquito, McIndoe &amp; Dental Forceps</i>	4-6
<b>Scissors</b> <i>Including Metzenbaum, Iris, Kilner, Reynolds, Vannas, Stevens Tenotomy and Westcott Scissors</i>	7-11
<b>Retractors</b> <i>Including Kilner "Catspaw" Retractor and Kilner Alae Hook Retractor</i>	11-12
<b>Curettes</b> <i>Volkman Bone Curette</i>	12
<b>Gillies Skin Hook</b>	13
<b>Blade Handles</b> <i>Including Scalpel Blade Handle No3 and No4</i>	14
<b>Needle Holders</b> <i>Including Mayo-Hegar, Halsey, Kilner and Barraquer Needle Holders</i>	14-16
<b>Sponge Holders</b> <i>Including Rampley Sponge Holder</i>	17
<b>Clamps</b> <i>Including Backhaus Towel Clamp</i>	17
<b>Dental Syringe</b>	17
<b>Bipolar Forceps</b>	18
<b>Suction Handles</b> <i>Including Cream Applicator</i>	18
<b>Instrument Wipes</b>	18

# Forceps

## BIRKS TYING FORCEPS

BTF2115 Birks Tying Forceps 110mm, 6mm Platform with 0.4mm Tips 20 units

- High quality tips for required precision
- Well balanced with effective grip
- Platforms that always meet

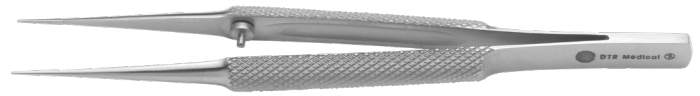
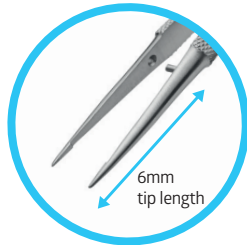
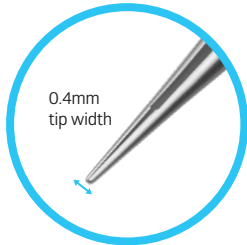

## FINE SUTURE FORCEPS

SPF2001-S Fine Suture Forceps Plain 105mm 20 units

SSF2001-S Fine Suture Forceps Serrated 105mm 20 units



For our extended range of Forceps, see our General Surgery catalogue

- 0.8mm tip width offers you enhanced accuracy to ensure first time results
- Delivers an excellent grip to help secure tissue and suture materials
- Provides flexibility required in delicate procedures

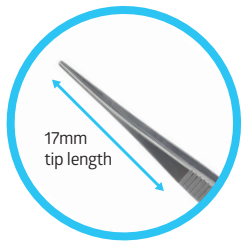
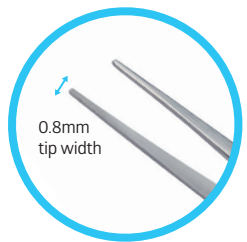
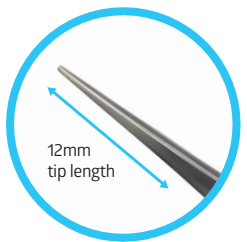

Fine Suture Forceps Plain



Fine Suture Forceps Serrated

## GILLIES FORCEPS

GDF2001-D Gillies Toothed Dissecting Forceps 160mm 20 units

- Toothed to ensure less pressure is required to adequately grip tough tissues
- Available with fine, narrow jaws
- 1:2 serrated teeth

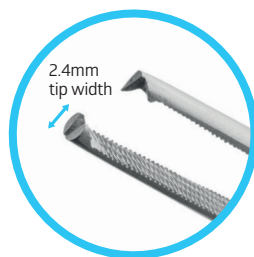
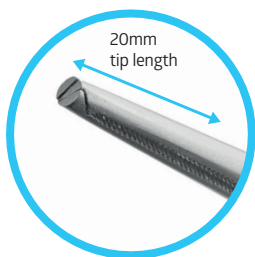



# Forceps

## EPILATION FORCEPS

EPF2085 Epilation Forceps 85mm, 2 x 3mm Plain Tips 20 units

- Smooth edges to reduce the risk of patient trauma
- High quality stainless steel with correct spring tension handle for greater control

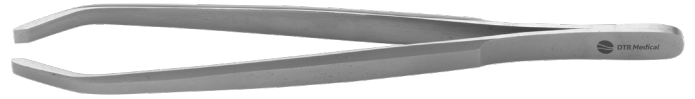
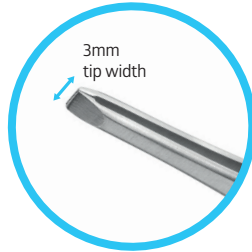
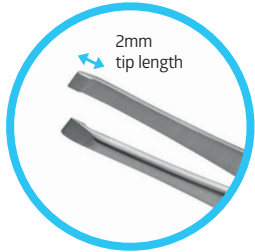

Epilation Forceps

## ADSON FORCEPS

ADS5001-S	Adson Non-Toothed Forceps 120mm	50 units
ATS5001-S	Adson Toothed Forceps 120mm	50 units
ATP2012-D	Adson Forceps 1x2 with plateau 120mm	20 units
ATP2015-D	Adson Forceps 1x2 with plateau 150mm	20 units
ATS2012F	Fine Tip Adson Toothed Forceps 1x2 with plateau 120mm	20 units

- Narrow tips to effectively grip and hold delicate tissue in place
- Flexibility across a wide range of procedures

Adson Fine Tip  
Toothed Forceps  
120mm

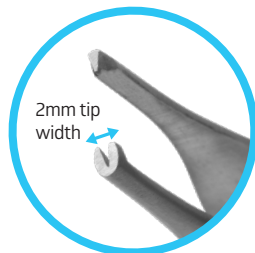

Adson  
Toothed  
Forceps

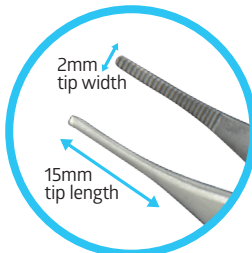

Adson  
Non-Toothed  
Forceps

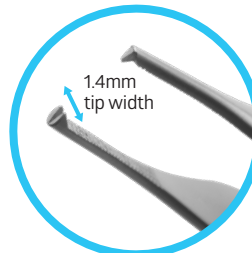

Adson  
Forceps  
with Plateau

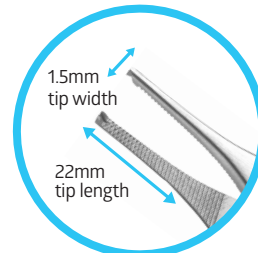

Fine Tip Adson  
Toothed  
Forceps

# Forceps

## MOSQUITO FORCEPS

MQC2012	Micro Mosquito Forceps 120mm Curved	20 units
MQT5001-S	Mosquito Forceps 125mm Straight	50 units

- Frequently used for small blood vessels
- Type of Hemostatic Forceps commonly used to control bleeding
- Robust locking ratchet and serrated jaws for holding tissue in place

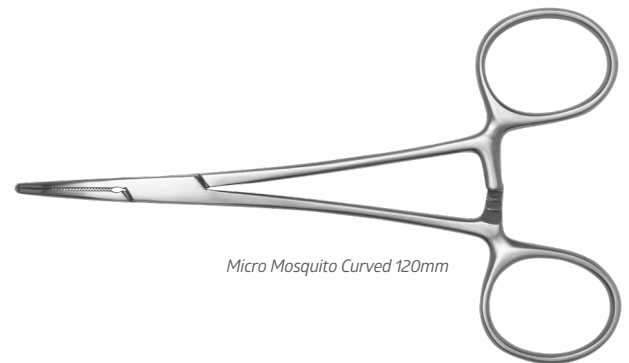
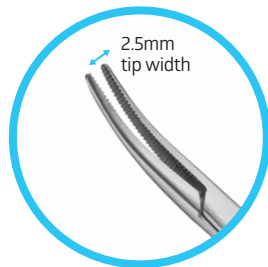

Micro Mosquito Curved 120mm



Mosquito Forceps Straight 125mm

## McINDOE FORCEPS

MDF5001-D	McIndoe Dissecting Forceps 150mm, Non-Toothed	50 units
-----------	---	----------

- Fine, non-toothed serrated jaws are ideal when repositioning delicate tissue
- Can be used to hold wound dressings and packing

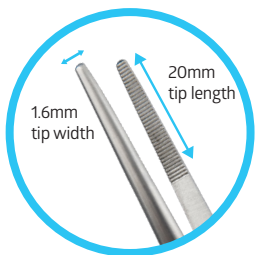

## DENTAL FORCEPS

CDF2001	College Dental Forceps 160mm	20 units
---------	------------------------------	----------

- Precision instrument with firm grip
- Good spring action

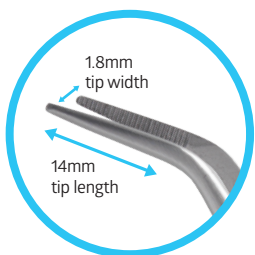

## EXTENDED RANGE

# Metzenbaum Scissors

### Metzenbaum Scissors

- First time performance for cutting delicate tissue and blunt dissection
- Specially engineered to be fine and precise
- Used during minor surgical procedures

### SuperCut Baby Metzenbaum Scissors

- Ideal for fine cutting of soft tissue and blunt dissection
- One serrated blade and one sharp cutting blade allows a superior grip and cut

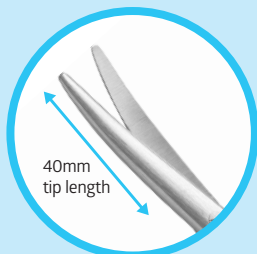

Baby Curved

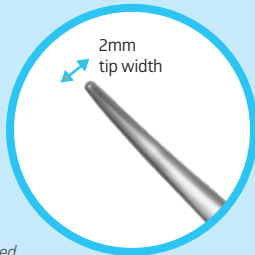
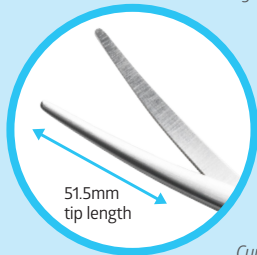

Curved

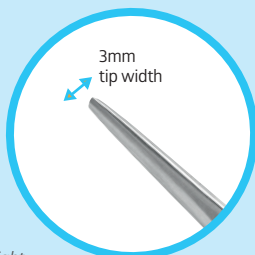
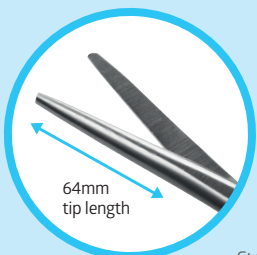

Straight

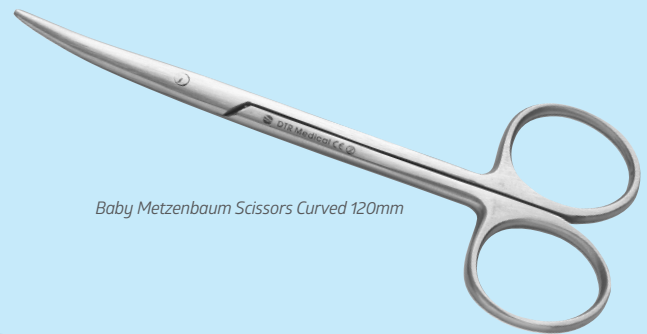

Baby Metzenbaum Scissors Curved 120mm

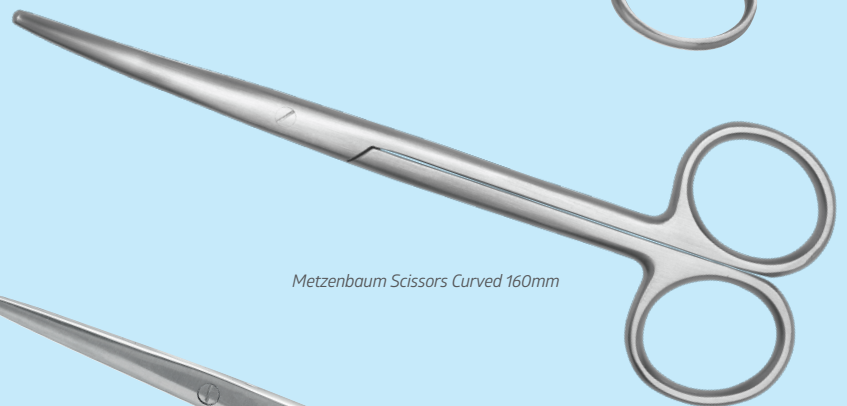

Metzenbaum Scissors Curved 160mm

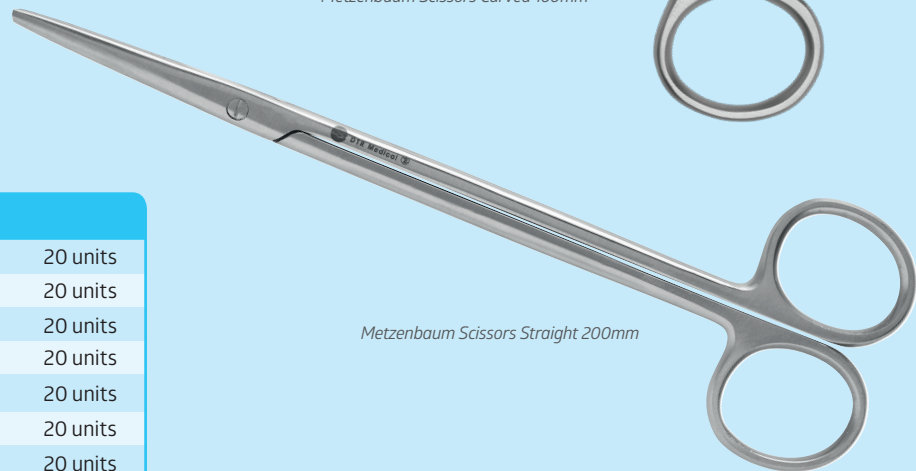

Metzenbaum Scissors Straight 200mm

### METZENBAUM SCISSORS

ZSC2121-D	Baby Metzenbaum Scissors Curved 120mm	20 units
ZSC2141-D	Metzenbaum Scissors Curved 145mm	20 units
ZSC2161-D	Metzenbaum Scissors Curved 160mm	20 units
ZSC2181-D	Metzenbaum Scissors Curved 180mm	20 units
ZSS2181-D	Metzenbaum Scissors Straight 180mm	20 units
ZSC2201-D	Metzenbaum Scissors Curved 200mm	20 units
ZSS2201-D	Metzenbaum Scissors Straight 200mm	20 units

NEW

### SUPERCUT BABY METZENBAUM SCISSORS

SZSC2121	SuperCut Baby Metzenbaum Scissors Curved 120mm	20 units
----------	--	----------

IMAGE COMING SOON

# Scissors

## IRIS SCISSORS

ISS2111-S	Iris Scissors Straight 90mm	20 units
ISC2111-S	Iris Scissors Curved 90mm	20 units
ISS2110-D	Iris Scissors Straight 110mm	20 units
ISC2110-D	Iris Scissors Curved 110mm	20 units

- Enhanced accuracy when it comes to delicate surgeries
- Available in both Straight and Curved variants
- First time sharpness which cut even at the tips
- Narrows to a fine and sharp point



*Straight*

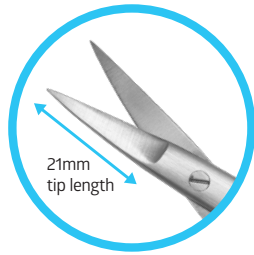

*Curved*



## NEW

## SUPERCUT IRIS SCISSORS

SISS2111	SuperCut Iris Scissors Straight 90mm	20 units
SISC2111	SuperCut Iris Scissors Curved 90mm	20 units

- One serrated and one sharp cutting blade allows a better grip and cut than traditional alternatives
- Sharp tips make the Scissors ideal for precise cutting of soft tissue, sutures, and wound dressings
- Available with straight or curved blades

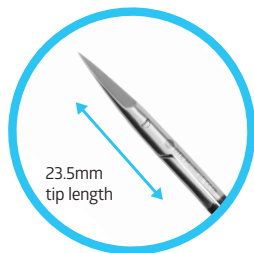

IMAGE COMING SOON

# Scissors

## KILNER SCISSORS

KSS2001-S Kilner Scissors 115mm 20 units

- Sharp tips allow precise dissection and cutting of delicate tissue

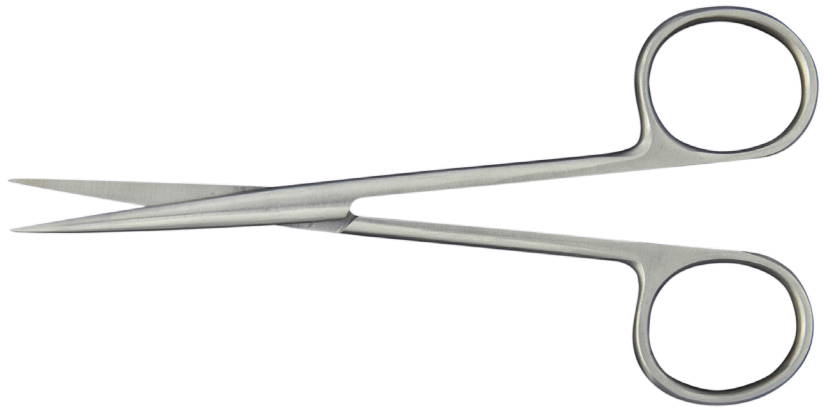
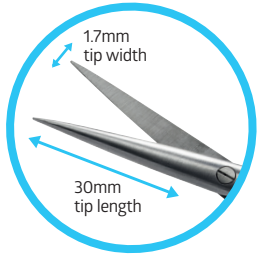

## REYNOLDS SCISSORS

RSC2014-D Reynolds Scissors Curved 145mm 20 units

- Fine tipped scissors enable a precise action when cutting and dissecting soft tissue
- 145mm length helps keep the clinician's hand out of view in demanding procedures

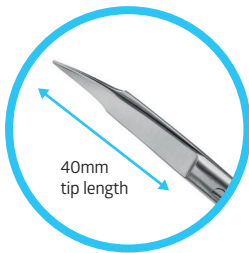



# Vannas Scissors

- High quality stainless steel cross action Scissors with fine sharp tips
- Both Straight options have 0.4mm tip width
- Curved option offers greater flexibility for delicate procedures
- Ideal for your most delicate practice, such as the removal of fine Sutures
- Equipped with a ridged handle and a double leaf spring mechanism for self-opening action, ensuring enhanced control

## Straight

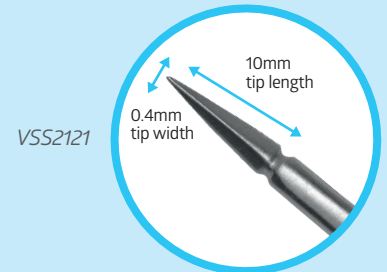
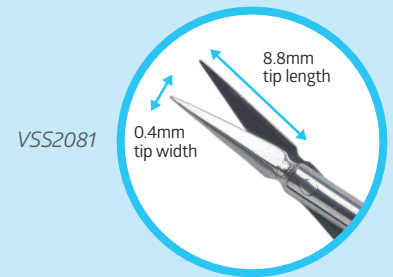

## Curved

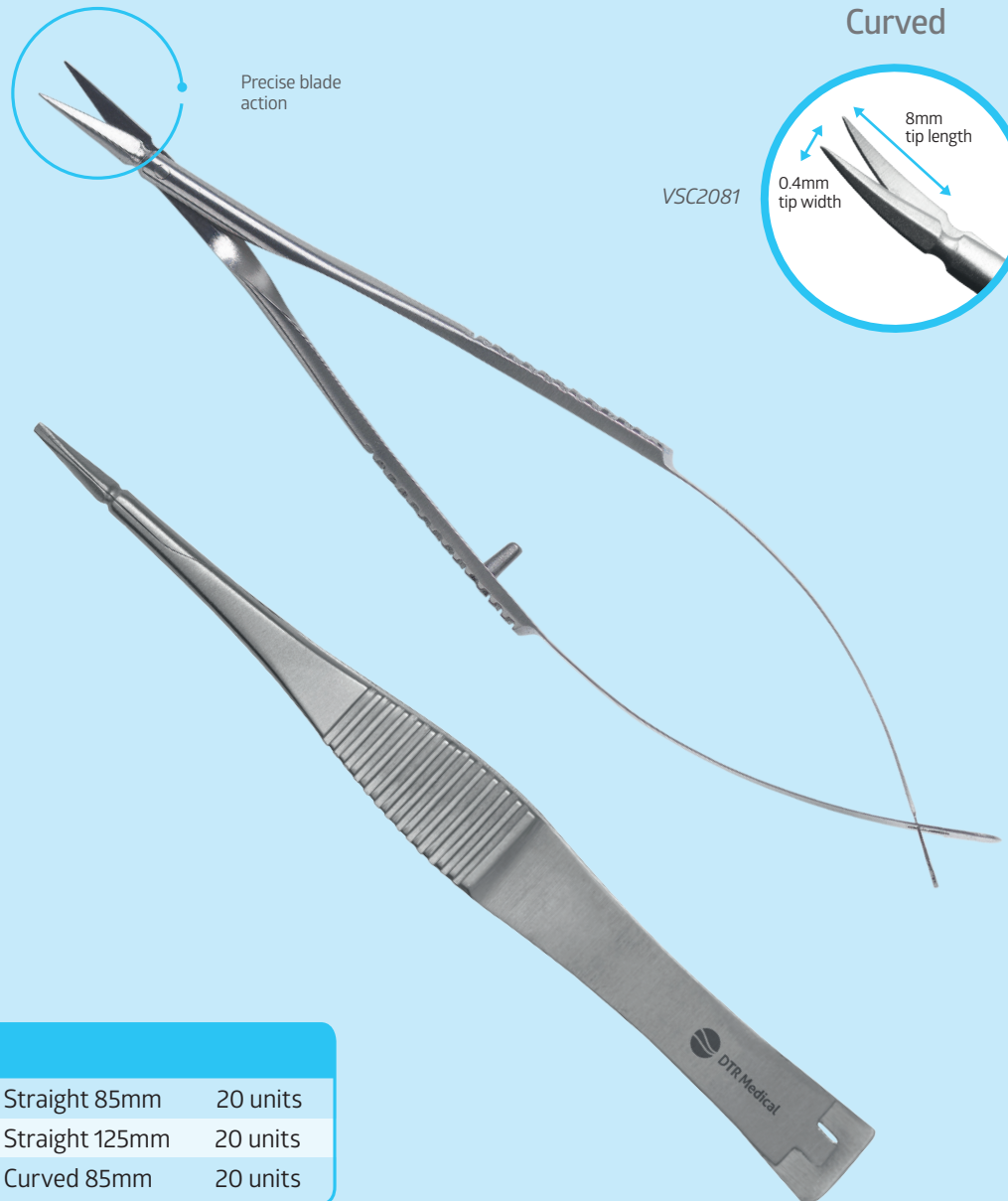
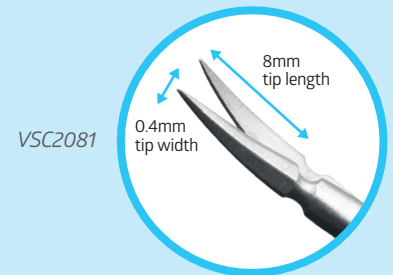

### VANNAS SCISSORS

VSS2081	Vannas Scissors Straight 85mm	20 units
VSS2121	Vannas Scissors Straight 125mm	20 units
VSC2081	Vannas Scissors Curved 85mm	20 units

# Scissors

## STEVENS TENOTOMY SCISSORS

TSS2001-S	Stevens Tenotomy Scissors 115mm Straight	20 units
TSC2001-S	Stevens Tenotomy Scissors 115mm Curved	20 units

- Stainless steel sharp/sharp Scissors
- First time sharpness which cut even at the tips
- Smooth and elegant long handle
- Allows increased grip and control when cutting in small or narrow areas

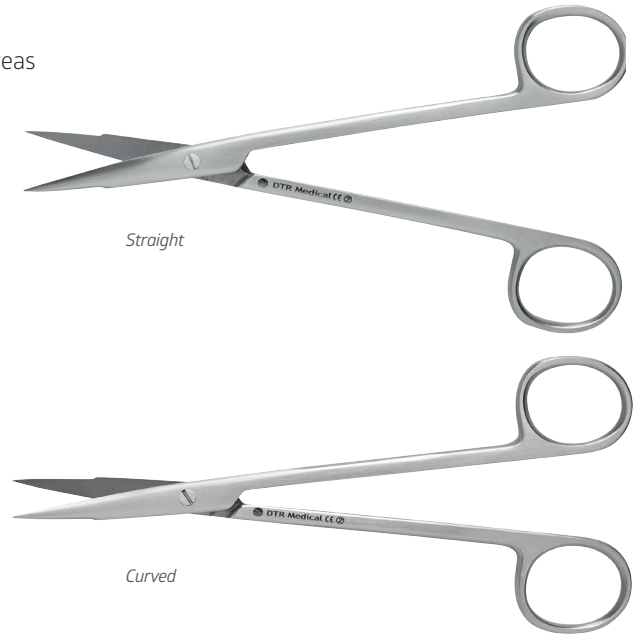
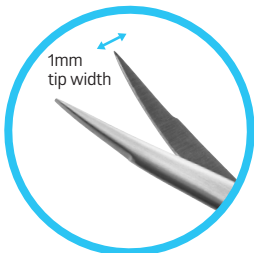
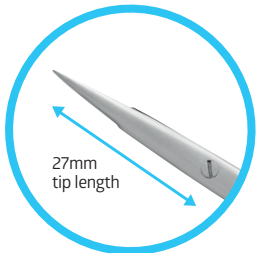
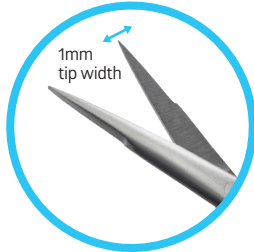
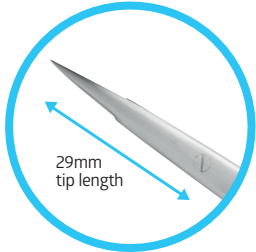

Straight

Curved

NEW

## SUPERCUT STEVENS TENOTOMY SCISSORS

STSS2001	SuperCut Stevens Tenotomy Scissors 115mm Straight	20 units
STSC2001	SuperCut Stevens Tenotomy Scissors 115mm Curved	20 units

- Ideal for delicate cutting and dissecting soft tissue
- One serrated blade and one sharp cutting blade allows a superior grip and cut
- Available with straight or curved blades

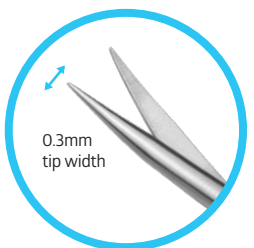
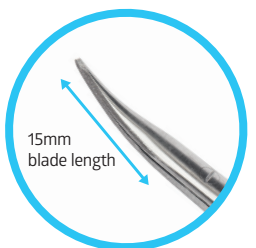

IMAGE COMING SOON

## WESTCOTT SCISSORS

WSC2115	Westcott Scissors Curved 110mm, 15mm Blade	20 units
---------	--	----------

- Cross action scissors with fine sharp tips
- First time sharpness for precise cutting action
- Ideal for delicate procedures such as Tenotomy and suture removal



# Retractors

## KILNER "CATSPA"W" RETRACTOR

KCP2001 Kilner "Catspaw" Retractor 155mm 20 units

- First time sharpness for precision
- Precise 2.2mm width prong end and hook blade guarantees reliability and performance

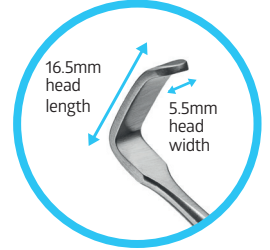
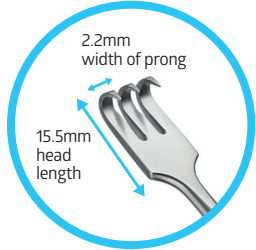

## KILNER ALAE HOOK RETRACTOR

KHR2001 Kilner Alae Hook Retractor 85 x 13mm hooks 20 units

- Effective retraction for surgical exposure

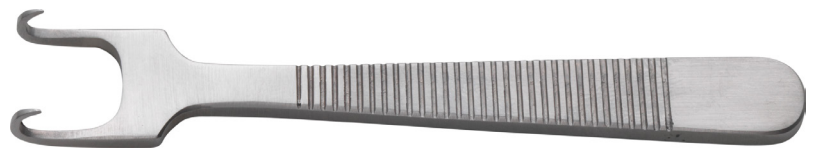
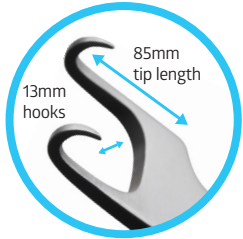

# Curettes

## VOLKMANN BONE CURETTES

VCD2013 Volkmann Bone Curette, double-ended 10/17mm scoop (Small), 130mm 20 units

VCD2613 Volkmann Bone Curette, double-ended 6/11mm scoop (Small), 130mm 20 units

- Offers flexibility in the removal of fibrous tissue
- Flat, serrated handles
- Sharp working edge that ensures improved control and accuracy

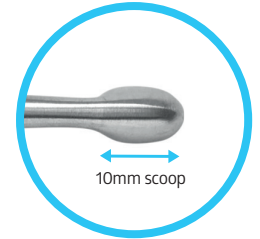

## Gillies Skin Hooks

- Available in both sharp and semi-sharp the 182mm Gillies Skin Hook offers you flexibility in a variety of procedures
- The sharp hook enables enhanced accuracy, grip and precision
- The semi-sharp hook is suitable for holding skin whilst taking a biopsy, minimising patient trauma
- Manufactured using high-quality stainless steel to ensure first-time sharpness



Semi-Sharp =  
0.7mm tip

Semi-sharp



Sharp =  
narrows to  
a fine and  
sharp point

Sharp



**“Amazing blunt Hook which I have found perfect for safely isolating and gently moving small blood vessels as well as using as a gentle Semi-sharp Gillies Skin Hook. Very well made and lovely to handle.”**

Prof. Mark Whiteley MS FRCS(Gen) FCPHleb, Consultant Venous Surgeon and Consultant Phlebologist, The Whiteley Clinic

### GILLIES SKIN HOOKS

GHS2001	Gillies Skin Hook Sharp 182mm	20 units
GHB2001	Gillies Skin Hook Semi-sharp 182mm	20 units

## Blade Handles

### SCALPEL BLADE HANDLES

SBH2031	Scalpel Blade Handle No 3	20 units
SBH2041	Scalpel Blade Handle No 4	20 units

- Universal add on
- Secure grip
- Eliminates cross infection



Scalpel Blade Handle No 3

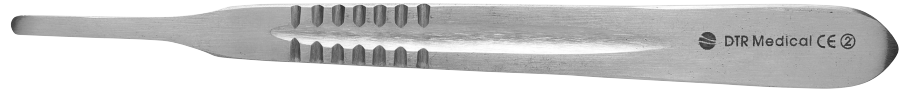

Scalpel Blade Handle No 4

## Needle Holders

### MAYO-HEGAR NEEDLE HOLDERS

MNH2013	Mayo-Hegar Needle Holder 130mm	20 units
MNH2015	Mayo-Hegar Needle Holder 150mm	20 units
MNHG2013-D	Mayo-Hegar Needle Holder with groove 130mm	20 units

- Serrated jaws for effective needle grip
- Features a central groove in which needle can be held

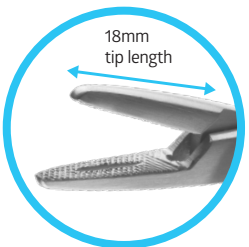

Mayo, 150 mm



Mayo with groove, 130 mm



# Needle Holders

## HALSEY NEEDLE HOLDER

HNH2013 Halsey Needle Holder 130mm 20 units

- Ratcheted, finger ring instrument for secure hold
- Used for holding small needles for suturing

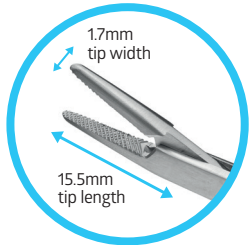

## KILNER NEEDLE HOLDER

KNH2013 Kilner Needle Holder 135mm 20 units

- Serrated tip for gripping
- S-curved handle for specific procedures

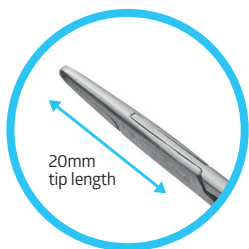

## Barraquer Needle Holder

- Non-locking handle with fine jaw for precision work
- Allows for greater control and easy rotation with the fingers only
- Cross-action, non-locking knurled handle and 9mm fine jaws for precision work
- Consistent results in delicate microsurgical procedures

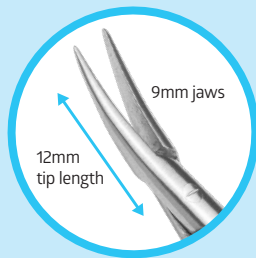

**"The Barraquer Needle Holder is beautiful."**

Ophthalmology Department, Wythenshawe Hospital

### BARRAQUER NEEDLE HOLDERS

BNH110C	Barraquer Needle Holder Curved 110mm	10 units
BNH210C	Barraquer Needle Holder Curved 110mm	20 units

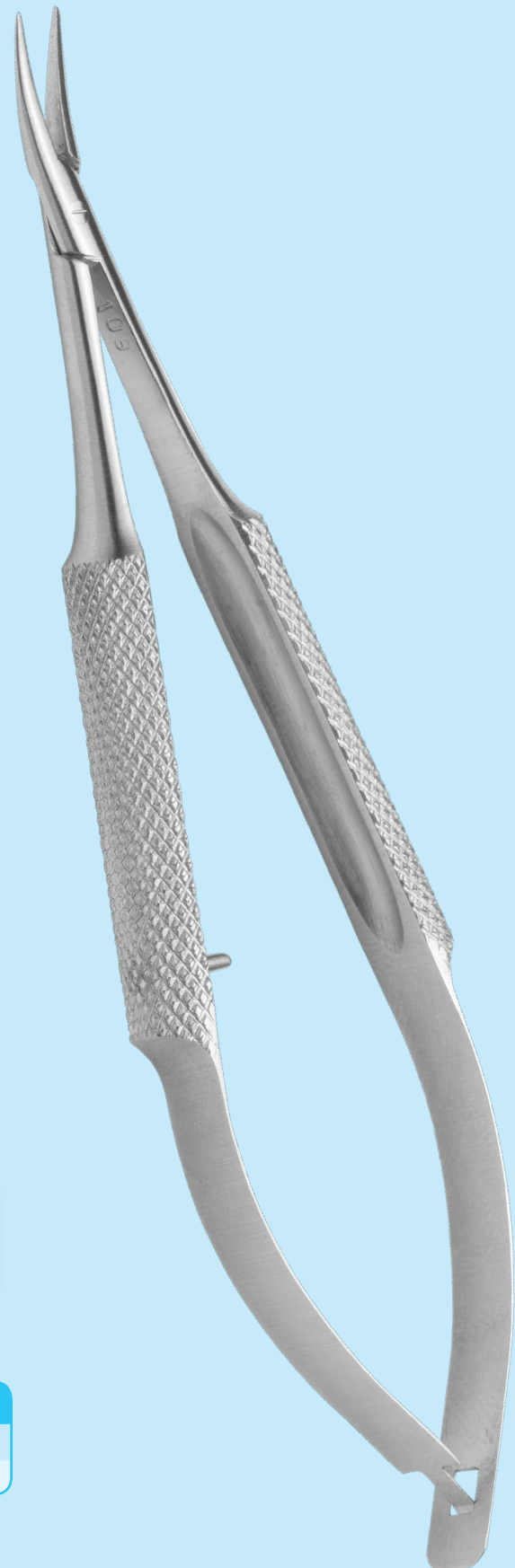

## Sponge Holders

### RAMPLEY SPONGE HOLDERS

RSH2181	Rampley Sponge Holder 180mm	20 units
RSH2241	Rampley Sponge Holder 240mm	20 units

- Strong jaws with an effective locking ratchet for effectively holding swabs and gripping tissue during procedures
- Robust grip

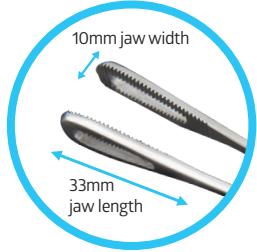

## Clamps

### BACKHAUS TOWEL CLAMP

BTC2013-D	Backhaus Towel Clamp 135mm	20 units
-----------	----------------------------	----------

- Strong grip for grasping tissue, towels or drapes

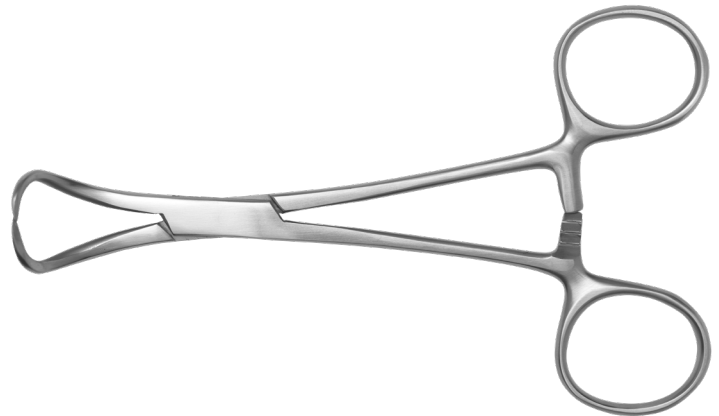
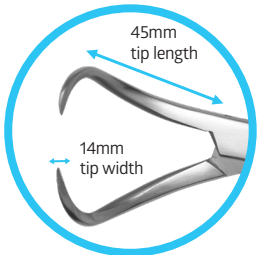

## Dental Syringe

### DENTAL SYRINGE

DGS2001	Dental Syringe 85mm for 2.2ml vial	20 units
---------	------------------------------------	----------

- Suitable for use where needle stick injury is a concern
- Compliant with latest EU legislation – prevention from sharps injuries
- Popular top loading style to accommodate 2.2ml vials
- Barrel diameter is wide enough to take most vials

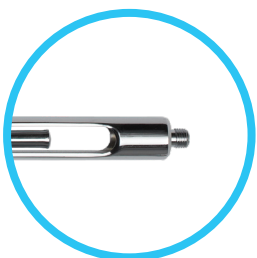

## Bipolar Forceps

### STANDARD BIPOLAR FORCEPS

SU770515044	Standard Bipolar Forceps 150 x 0.5mm, 3m, 4mm Plugs	20 units
SU770520044	Standard Bipolar Forceps 200 x 0.5mm, 3m, 4mm Plugs	20 units
SU771015044	Standard Bipolar Forceps 150 x 1mm, 3m, 4mm Plugs	20 units
SU771520044	Standard Bipolar Forceps 200 x 1.5mm, 3m, 4mm Plugs	20 units
SU772015044	Standard Bipolar Forceps 150 x 2mm, 3m, 4mm Plugs	20 units
SU772020044	Standard Bipolar Forceps 200 x 2mm, 3m, 4mm Plugs	20 units

- Fine stainless steel tips with a range of sizes from 0.5 - 2mm
- Adjustable and universal 4mm plug that is tested to comply with the Flying Leads legislation
- High quality cables and connectors deliver consistently repeatable results

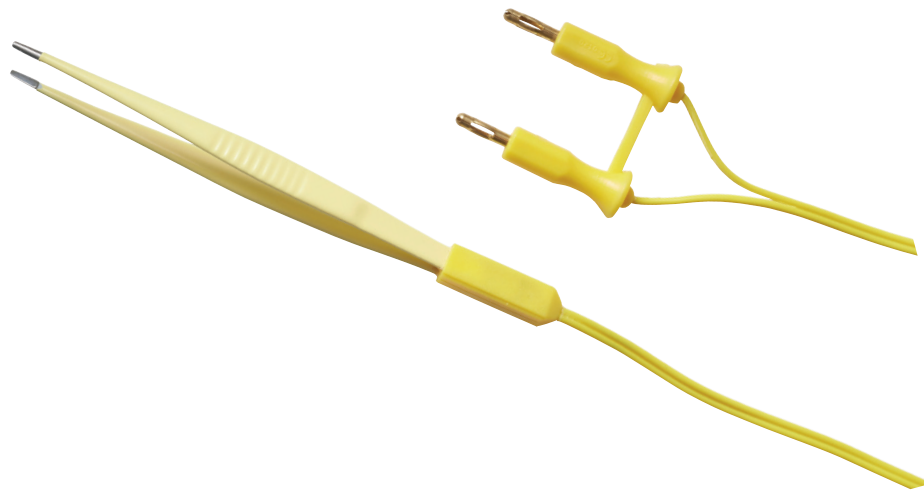

## Suction Handles

### CREAM APPLICATOR

ECA5001-S	Cream Applicator 86mm long x 6Fg	50 units
-----------	----------------------------------	----------

- Cream or ointment applicator for use with luer lock syringe



## Instrument Wipes

### NETCELL® PVA INSTRUMENT WIPE

35-900	PVA Instrument Wipe	20 units
--------	---------------------	----------

- Quickly removes protein, blood and particles without damage to the instrument
- Manufactured from ultra-smooth, biocompatible PVA sponge that will not snag
- Soft, strong, flexible, fibre and snag free material



## "Supporting visibility, quality and safety in your supply chain"\*\*\*

Our instruments' packaging features the latest machine readable GS1-standard barcoded labels for product traceability.

The newly incorporated labelling technology is a timely development with an increasing number of health providers worldwide adopting an 'eProcurement' strategy and will provide machine readable product information on all labels to meet expected EU and other regulators demands.

### Associated benefits include:

- Improve patient care and reduce costs
- Improve stock control
- One global language
- Accurately track equipment

*"Unique device identification (UDI) compliance represents a significant development for our customers. Automation of information flow will have influences across the whole purchasing and supply process, providing the benefits of superior instrument traceability and improved patient safety."*

*"We are working closely with Kodit UDI software to provide our labelling solutions to meet the latest international regulations and we serve as a reference site for other manufacturers to learn from."*

DTR Medical

For more information on our new product labelling, please contact Customer Services on +44 (0) 1792 797910 or [dtrinfo@innoviamedical.com](mailto:dtrinfo@innoviamedical.com)

\*\* - GS1 – Global Traceability Standards

### Matching reusable standards

We benchmark against reusable British and international standards:

#### **BS 5194-1:1991**

(Inc ISO 7153 – 1:2001) Surgical Instruments - (Metallic Materials and Stainless Steel)

#### **BS 5194-2:1989**

Specification for Instruments with Pivot Joints

#### **BS 5194-3:1985**

Specification for Dissecting Forceps

#### **BS 5194-4:1985**

Specification for Scissors, Shears and other Jointed Instruments

We operate our own UK production facilities equipped with ISO class 7 cleanrooms.



**DTR Medical**

Dermatology - Single-Use Instruments

**DTR Medical Ltd**

**An Innovia Medical Company**

17 Clarion Court, Enterprise Park, Swansea SA6 8RF UK

Telephone: +44 (0)1792797910

[dtrinfo@innoviamedical.com](mailto:dtrinfo@innoviamedical.com)

**US 1.888.229.2875 | International +44 (0)1792797910**

[www.innoviamedical.com/single-use-instruments](http://www.innoviamedical.com/single-use-instruments)